

Pharma IT solutions for demanding environments



BLUE LINE
IT for Demanding Environments

Content

Reliable solutions for Pharma & Biotech IT	4
Meets regulatory requirements	6
Easy to use	8
Modular design	10
Mobile cleanroom solutions	12
Mobility in cleanrooms	14
Cleanroom Tablet	16
Mobile Operator Station T3000	18
Mobile Operator Station T2000	20
Fixed installations	22
Authentication - Go passwordless	28
Add-ons/accessories	32
Keyboards & mice	34
Add-ons - For cleanroom HMIs	36
Add-ons - For Mobile Operator Stations	37
Add-ons - For Cleanroom Tablet	38
About Blue Line	40
Quality and sustainability	42

Reliable solutions for Pharma & Biotech IT

Reliable IT hardware based on your environment and needs. Blue Line's product line is compliant with all regulatory requirements in GMP, FDA, and ISO 14644, allowing you to optimize workflow.



We understand your environment

Blue Line has been a global supplier of highly reliable IT solutions for demanding environments for more than 35 years. Our DNA is customer focus in all phases of the cooperation. In surveys, the majority of our clients emphasized Blue Line's ability to listen and to create solutions in close cooperation with our dedicated team.



Higher productivity and user satisfaction

Benefit from a product range designed to avoid the typical challenges in biotech and pharmaceutical manufacturing. Renew or retrofit current IT installation and gain higher productivity and user satisfaction.

Benefit from experience and knowledge based on numerous installations worldwide.



Quality and reliability

All products are designed for 24/7 uptime, with low power consumption, passive cooling, and without moving parts for maximum operational reliability. All company procedures are subject to strict quality standards in the ISO 9001:2015 certification. As a company, we also hold an AAA credit rating.

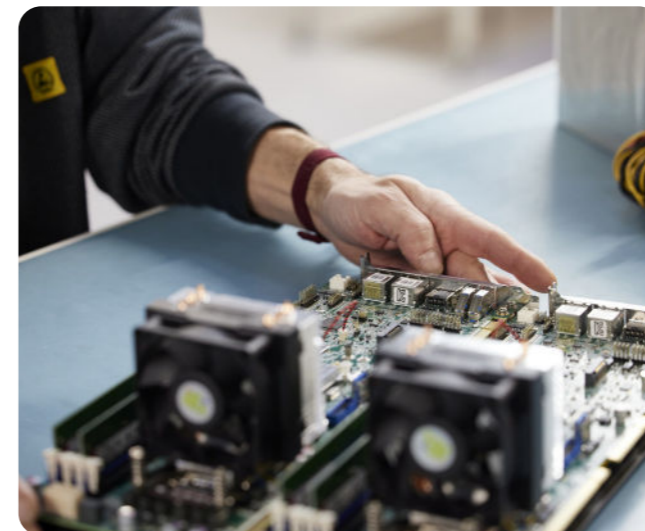

Meets regulatory requirements

Benefit from a product range designed to avoid typical challenges in pharmaceutical manufacturing. Avoid worries about regulatory requirements with innovative technologies keeping products completely clean and sterile.



Compliant with all standards

Take advantage of our extensive experience with IT for cleanrooms.

Blue Line's products comply with all regulatory requirements for EU GMP classification for cleanroom A-B-C-D, as well as FDA and ISO 14644.



Easy to clean

All products are consciously designed with smooth surfaces, slanted sides, and rounded edges, meaning that products are easy to clean.

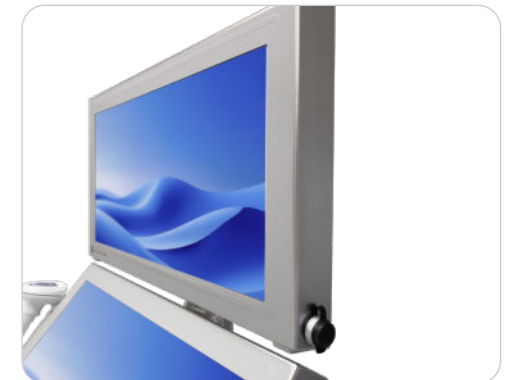

Withstands all known cleaning detergents

Blue Line's cleanroom products withstand all known cleaning detergents such as iso-propyl alcohol, non-deionized water, VHP, Spor-Klenz™, Klercide, Actisan, LpH®, Vesphene®, and many more.



Easy to use

Do you find that fixed-mounted operator terminals can be inflexible and cost-intensive? Go mobile and achieve greater productivity, a more flexible setup as well and reduced costs.

Operable with gloves

Blue Line's cleanroom workstations support operation with gloves. A typical use case would be operation with two or three layers of gloves.

The innovative touch display includes auto calibration for seamless operation and avoids interruptions in the production process.



Hygienic keyboard

Standard keyboards are not suitable for use in cleanrooms, as dirt accumulates under the keys and trackball.

Furthermore, the design and materials of most keyboards do not permit regular cleaning with aggressive agents. The surface of Blue Line's hygienic keyboard is completely flat and can be effectively disinfected with no compromises.

Blue Line's touch keyboards are without moving parts, ensuring long durability and long-term reliability.

If you prefer a keyboard with keystroke, all Blue Line HMIs are also available with membrane keyboards.



Modular design - Built to your needs

Blue Line's modular design makes it possible to configure the majority of HMI Workstations and Mobile Operator Stations to specific needs in functionality, finish, and environment.

Choose between different variants on the basis of casing, size, input, communication, and mounting.

Discover the possibilities below. If you do not find a combination that fits your requirements, Blue Line has a strong capability to customize products according to your specifications.

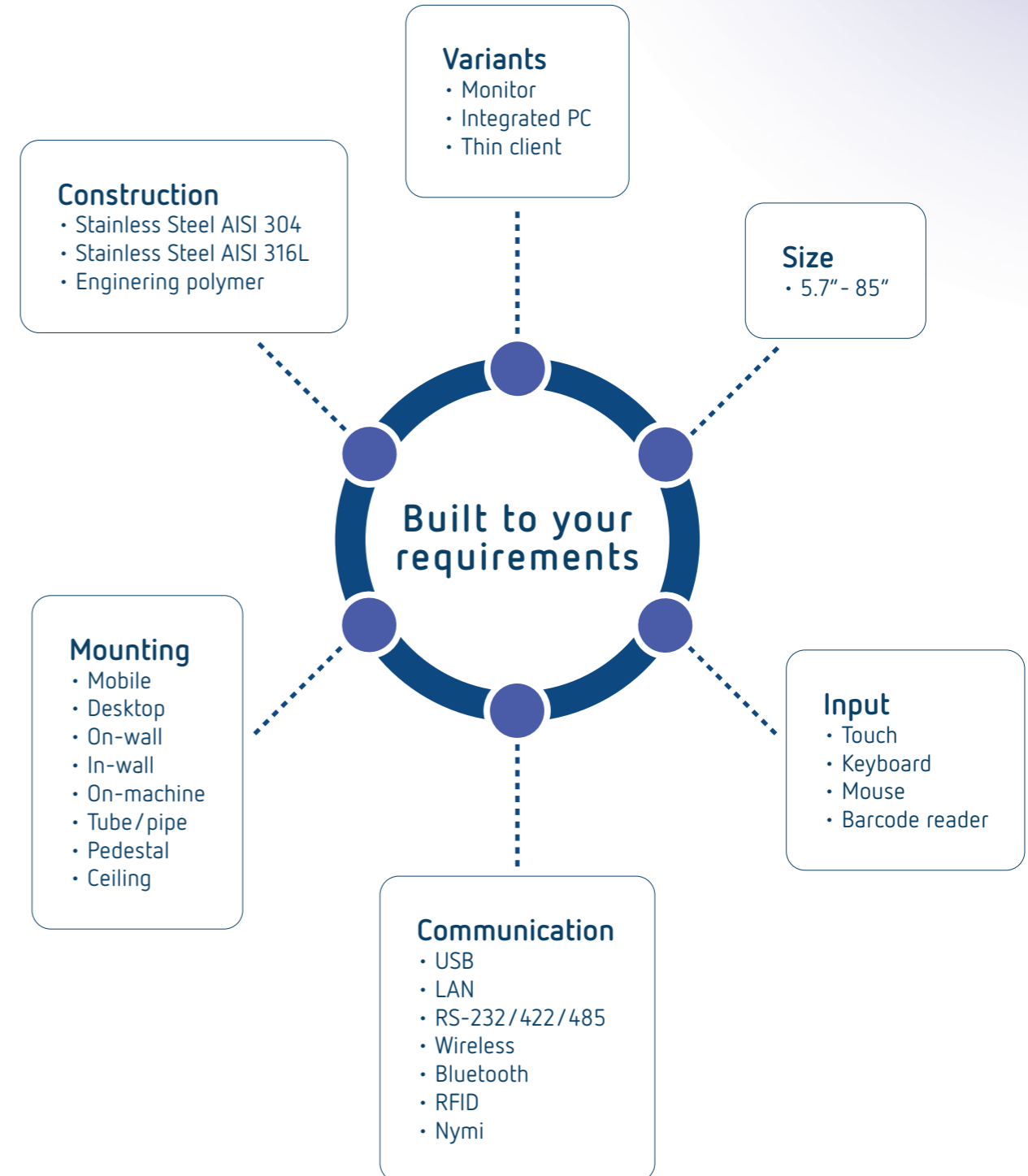

Mobile cleanroom solutions



Mobility in cleanrooms

Do you find that fixed-mounted operator terminals can be inflexible and cost-intensive? Go mobile and achieve greater productivity, a more flexible setup as well as reduced costs.

Why go mobile?

Mobile IT solutions in pharma and biotech enhance productivity, flexibility, and data access, improving product development, clinical trials, and regulatory compliance.

They optimize processes with real-time data access, facilitate immediate documentation and data entry, reduce the need for fixed workstations, and adapt to different tasks or production areas.

These solutions support regulatory adherence with mobile documentation, operate across various facility zones, and improve ergonomics and ease of use.



Implementation in cleanrooms

Mobile solutions bring full flexibility to cleanroom operations, reducing setup time and lowering infrastructure costs. Lightweight, ergonomic designs make devices easy to handle, clean, and integrate seamlessly into GMP-, FDA-, and ISO-compliant environments.

With configurable Mobile Operator Stations and compact Cleanroom Tablets, teams can work efficiently across different zones and tasks, adapting to evolving production needs without compromising cleanliness or safety.

These solutions combine mobility, usability, and compliance, providing a practical and future-ready approach to cleanroom IT.

Mobile Operator Stations

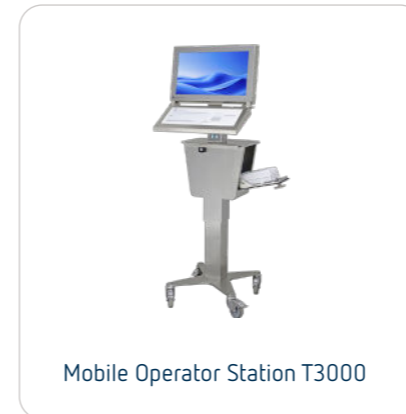

Mobile Operator Station T3000

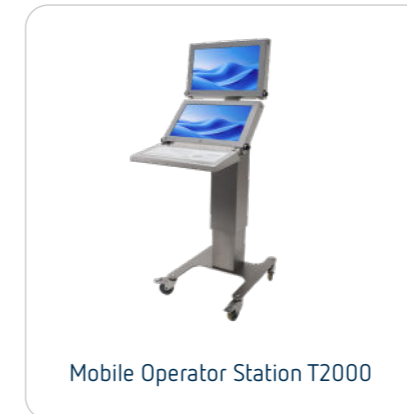

Mobile Operator Station T2000



Mobile Operator Station T500

Tablet

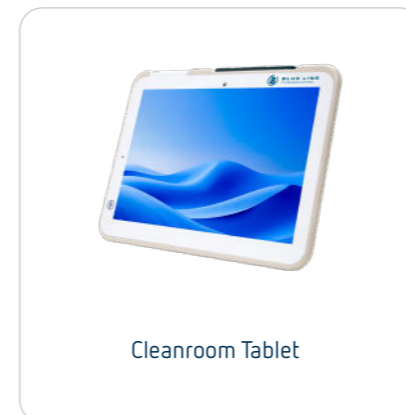

Cleanroom Tablet

Cleanroom Tablet

The lightest and thinnest cleanroom tablet ever on the market. Easy-to-clean design with smooth unbroken surfaces. Detergent resistant and operable with gloves.

The first GMP compliant tablet with real cleanability and true mobility for cleanroom operation.

Very easy to clean and disinfect due to complete smooth surfaces without any openings or crevices where unwanted contaminants can accumulate.

Suitable for repeated cleaning cycles withstanding all known cleaning agents and disinfectants.



Withstands all known detergents. Easy-to-clean design with smooth unbroken surfaces compatible with gloves.

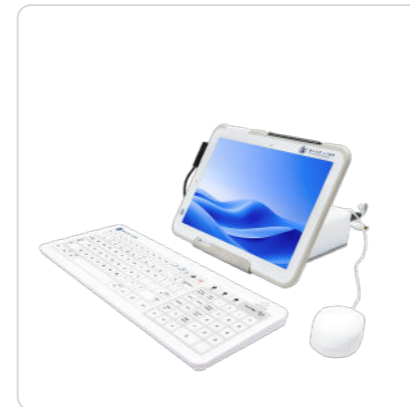

Add a Cleanroom Hub - the ultimate solution for charging and wired connectivity



Touch pen - magnetic and light weight



Charger for 4 tablets



Compact dimensions and low weight, up to 60% lighter and 60% thinner



13" multi touch display



Integrated Nymi-reader

Mobile Operator Station T3000

The life science industry is going mobile, and Blue Line is at the forefront of this trend with a line of Mobile Operator Stations. A mobile strategy enables complete digitization, increases productivity, quality, and operational efficiency, and saves costs compared to fixed-installed HMIs.

Mobile Operator Station T3000 is the most complete operator station offering ultimate mobility and ergonomics for IT operation in cleanrooms and biotech.

Enable full digitization of workflows and achieve a flexible position that is prepared for future needs for changes in production.



Features



Single screen configuration

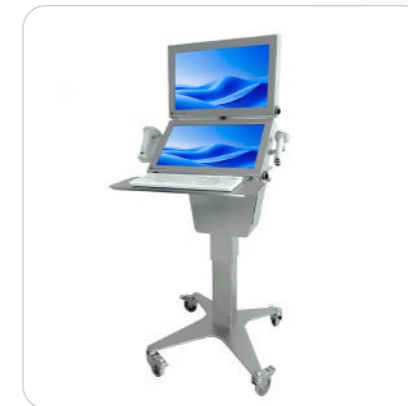

Dual screen configuration



Option for integrated thin client



Adjustable height for the best ergonomics



Hot-swappable batteries



Configurable workspace



Display for battery power status



Integrated WIFI and Bluetooth



Stainless steel surfaces

Mobile Operator Station T2000

The T2000 offers the mobility of the T3000 in a cost-effective unit that ensures complete digitization and productivity in cleanrooms. Take advantage of the ergonomic design that eases the usability for cleanroom operators.

The Mobile Operator Station T2000 delivers essential mobility and ergonomics for IT operations in cleanrooms and biotech environments.

The T2000 maintains full functionality while offering a streamlined and cost-effective approach to mobile cleanroom technology.



Features



Single screen configuration



Dual screen configuration



Option for integrated thin client

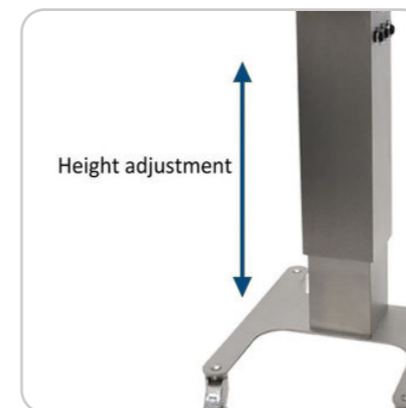

Adjustable height for the best ergonomics



Ergonomic for operator comfort



Stainless steel surfaces



Integrated WIFI and Bluetooth

Fixed installations



Fixed installations

Fixed IT installations prioritize performance and data integrity, essential for regulatory compliance in pharma and biotech environments. Compliance and validation is simplified and the fixed equipment offers a direct connectivity with complex machinery.



Fitted to your environment

The mounting solutions are designed to ensure smooth transitions between the individual components making cleaning easy.

Made entirely of stainless steel, all mounting solutions are ingress proof withstanding tough cleaning procedures.

Based on your specific needs, we are pleased to prepare a proposal that ensures the best functionality, ergonomics and occupies as little space as possible.

HMI systems for fixed mounting



HMI
Monitor/Panel PC



HMI with Keyboard
Monitor/Panel PC



HMI 8000
Monitor/Panel PC



In-wall HMI
Monitor/Panel PC



HMI Atex/Ex
Monitor/Panel PC



Mounting options

Blue Line provides a wide range of flexible mounting solutions regardless of whether the mounting is to be done in the wall, on the wall, floor, ceiling, desktop or a machine.

Installations can be fixed, rotating, tiltable or even mobile. Separate or attached keyboards can be a part of the system.



In-wall



Wall or machine mounted



Ceiling mount



Floor mount



Desktop



Authentication



Authentication - Go passwordless

Are your teams losing valuable time with cumbersome login procedures? Modernize your authentication approach to eliminate passwords, reduce contamination risks, and boost operational efficiency across your pharma or biotech facility.

Enhancing security and efficiency

Utilizing the contactless and hands-free capabilities of the Nymi Band, a singular authentication method not only enhances security but also significantly improves operational efficiency.

This eliminates the need for operators to repetitively input their usernames and passwords or manually apply e-signatures, thereby concurrently mitigating the risk of unauthorized access or security breaches.



Seamless integration and user experience

The Nymi Band's seamless integration with production systems and its user-friendly interface ensures a smooth transition for your workforce.

The intuitive nature of the technology reduces the learning curve, allowing employees to adapt quickly and continue their work with minimal disruption.



Purpose-built for highly regulated environments

The Nymi Band is designed to operate in highly regulated environments, ensuring security, compliance, data integrity, and productivity.

Incorporating Blue Line's extensive industrial knowledge and valuable customer input, our pharmaceutical solutions now seamlessly integrate with RFID authentication using Nymi technology. This integration streamlines production, enhances security, and offers compliance-friendly reporting within pharmaceutical manufacturing facilities.

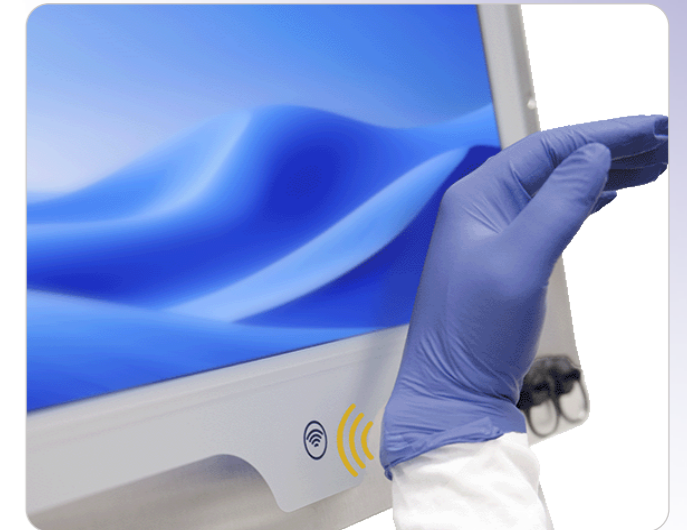

Technology partner



Nymi is a leading company in the field of biometric security, providing state-of-the-art authentication solutions. These solutions guarantee data integrity and offer strong security measures, enabling highly regulated industries to uphold compliance while improving productivity.

Add-ons/ accessories



Add-ons - Keyboards & mice

Integrated keyboards

Our cleanroom keyboards feature a completely clean and smooth surface for use in sterile environments such as cleanrooms, life science facilities, pharmacies and laboratories.

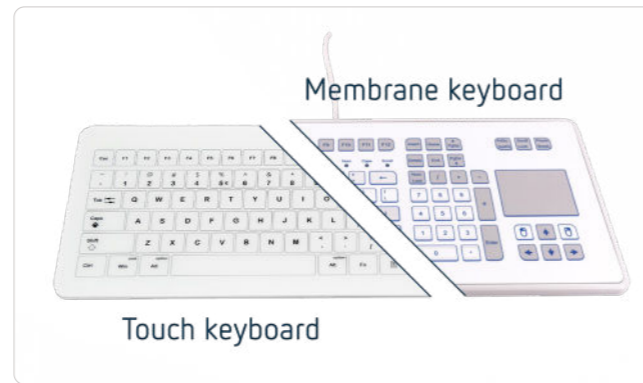

Choose between capacitive touch or tactile membrane keyboard



Hinged keyboards

All keyboards are available in steel housing for mounting in your cleanroom environment. The sealed stainless steel housing can be mounted on walls, HMIs, or machines using adjustable or fixed hinges. Without moving parts, Blue Line's touch keyboards ensure long-term reliability and durability in demanding environments.



Available as hinged keyboard in stainless steel housing



Cleanroom bluetooth keyboard



Cleanroom touch keyboard



Cleanroom keyboard in stainless steel housing



Optional stainless steel keyboard shelf



Water- and dustproof keyboard

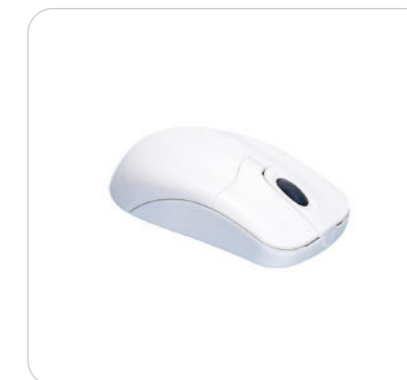

Water- and dustproof wireless mouse



Cleanroom laser mouse

Add-ons - For cleanroom HMIs

Add-ons - For Mobile Operator Stations

Nymi-reader



Integrated RFID/NFC reader

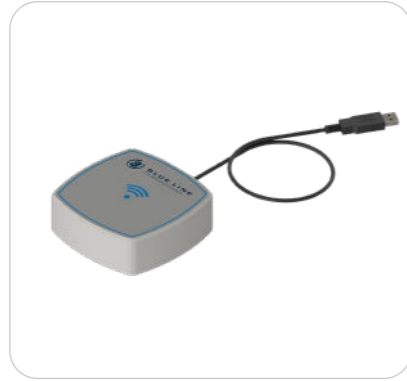

Desktop RFID/NFC reader



Wearable Nymi Band



Hot-swappable batteries



Battery charger for 2 batteries



Wide range of table configurations

Scanner & scanner mounts



Scanner



Scanner mounting



Scanner mounting

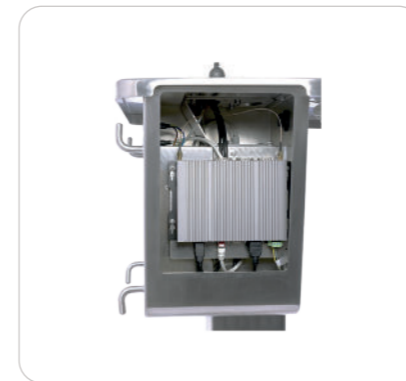

Compartment box for thin client

Add-ons - For Cleanroom Tablet

The Cleanroom Hub

The Cleanroom Hub is the ultimate solution for charging and wired connectivity. With 1 Ethernet and 3 USB connections, it offers seamless and simultaneous connectivity.

Designed for easy and safe use, it comes with an integrated stand that allows for both horizontal and portrait modes, making it perfect for desktop use. It's also enclosed in a cleaning-friendly IP65-proof casing, ensuring that it's always clean and safe to use.



Nymi-reader



Integrated RFID/NFC reader



Wearable Nymi Band

Mounting



Charger for 4 tablets



Touch pen - magnetic and light weight



USB-A data cable



Holder for desktop, wall or supporting arm - stainless steel 316L



Adjustable gas arm



Scanner



Bluetooth keyboard



Laser mouse

About Blue Line

As industry leaders, Blue Line's mission focuses on ensuring uninterrupted performance in environments where traditional IT solutions are not enough.



More than three decades of IT excellence

Drawing on more than 40 years of expertise in the rugged IT sector, Blue Line's solutions deliver positive results in customer sites worldwide and cover industries like pharmaceutical, defense, maritime, food production, AI, and automation.

Whatever the industry, your requirements are at the forefront of our solutions. Everything springs from client needs, ensuring products designed in full compliance with all relevant regulations and requirements across multiple industries. Clients benefit from purpose-built technology that addresses their needs while maintaining regulatory compliance.

Framework for mutual success

Commitment to excellence is reflected in our ISO 9001:2015-rated management system certification, which ensures consistent quality across all of our operations. In addition, a AAA credit rating maintained for 12 years provides clients with assurances of financial stability.

This framework means customers receive reliable products, transparent processes, and a relationship backed by recognized standards – eliminating uncertainty and strengthening the entire value chain.

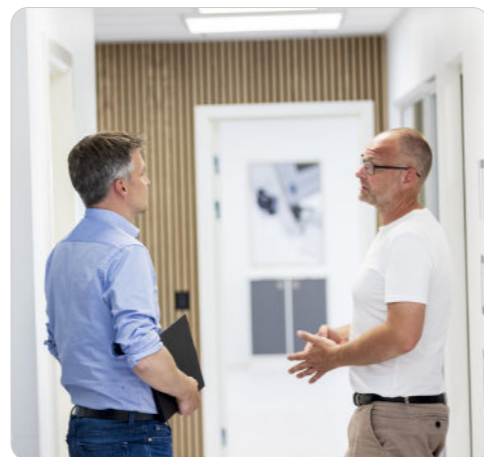

Sustainable partnerships

One of the key tenets of Blue Line's partner strategy is enabling companies to confidently partner with an organization dedicated to sustainability and integrity. This is reflected in, among other things, our strict ethical standards and a comprehensive Code of Conduct for our suppliers.

Balancing business success with environmental responsibility creates measurable value for our customers. The aim is to implement policies focused on energy efficiency, waste reduction, and recycling. This translates into customers gaining a trusted partner dedicated to quality, sustainability, and positive community impact.

Expanding reach and capabilities

Since our inception, Blue Line has undergone transformative growth that continues to this day. 2023 saw the establishment of a new headquarters in Hinnerup, Denmark, which quadrupled operational capacity. Then came a strengthening of our Scandinavian presence by expanding into Norway and Sweden, where our focus includes defense, telecom, marine, transportation, and AI/GPU solutions.

The most recent expansion marked a pivotal milestone in Blue Line's global journey, with the establishment of a US subsidiary in North Carolina's Research Triangle Park, positioning us perfectly to support our growing North American customer base.

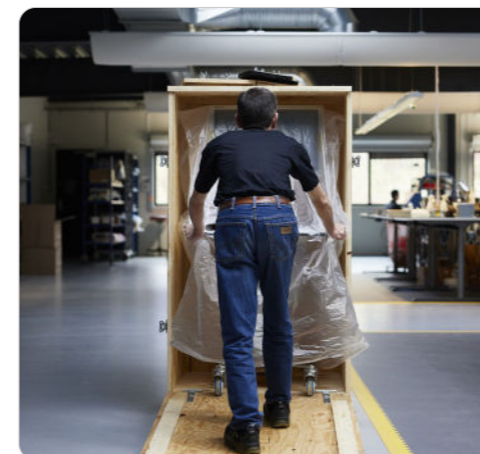

Securing your delivery time

At Blue Line, we understand the critical importance of proactive delivery planning and transparency with customers. To ensure optimal delivery performance, we've built strategic, long-term partnerships with our subcontractors.

Through substantial investments in our supply chain, customers can avoid the pain of component shortages and severe delivery delays that many industries have experienced in recent years.

Quality and sustainability

At Blue Line, a commitment to quality and sustainability is deeply ingrained in everything we do. It's not just a set of policies, but a fundamental part of our DNA that guides our actions and decisions every day.

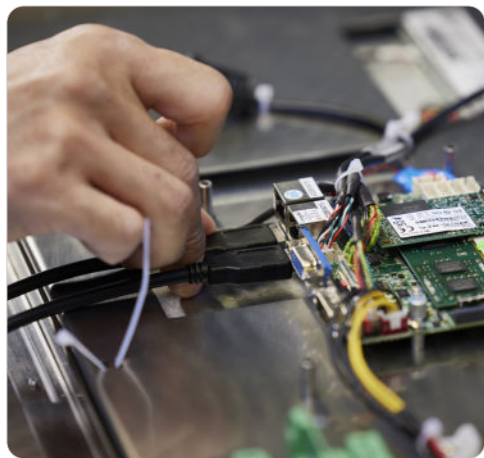

Excellent industry standards

Every year, we review our goals and policies, ensuring a constant push to be better. This management system is audited annually by DNV, while sustainability performance is assessed by Ecovadis.

Over the past three years, hard work has gone into consistently enhancing this Ecovadis sustainability score. This dedication has paid off – as of April 2024, we're proud to rank among the top 19% of companies assessed. The objective is to further elevate our rating to the prestigious Gold level within the next five years through targeted sustainability initiatives across our operations.

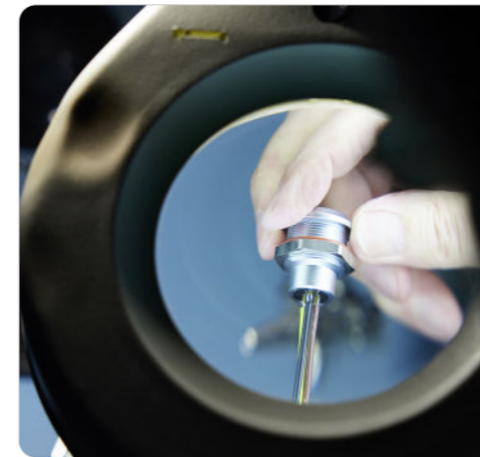

Sustainable sourcing

Sustainable sourcing is another key part of the Blue Line approach. Evaluating the sustainability of our supply chain in various parameters is crucial and therefore we have implemented a Code of Conduct for our suppliers. Working with suppliers who share our commitment to sustainability is a major priority.

Anti-corruption policy

Blue Line maintains a zero-tolerance policy for any form of corruption. Clear anti-corruption guidelines and reporting procedures are in place to ensure the highest standards of business ethics.

Comprehensive policies

To support our commitment to quality, sustainability, and ethical practices, we've established a comprehensive set of policies and procedures. These cover crucial areas like the environment, work conditions, employee rights, inclusion, anti-corruption, and more. These policies are publicly available on our website and audited annually by management to ensure accountability.

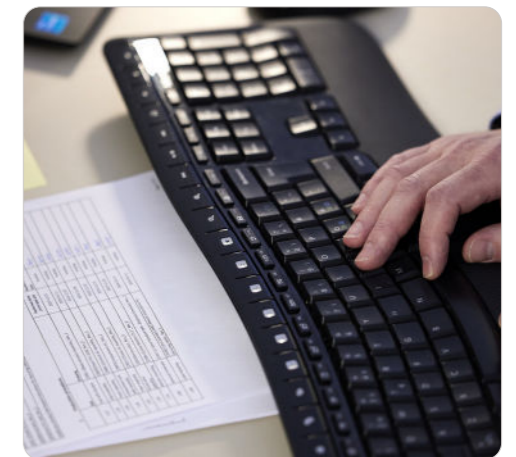

Social responsibility

Commitment to doing business the right way extends to social responsibility as well. We strive to balance the interests of all our stakeholders – from our employees and customers to our suppliers and the communities we operate in. This means fostering a work environment that promotes talent, inclusion, and job satisfaction, while also respecting national legal frameworks and the UN Global Compact principles on human rights and employee rights.



Environmental policy

Reducing environmental impact is a major part of our sustainability efforts. Every Blue Line employee contributes to complying with our environmental policy, which covers focus areas such as energy usage, waste reduction, and recycling. Because we believe that sustainability is a shared responsibility.



Our values and commitment

Dedication to quality and sustainability isn't just a corporate obligation – it's a heartfelt commitment that is integral to our long-term success. It's about being a trusted partner to our customers, a responsible employer to our team, a fair client to our suppliers, and a positive force in the broader community.

Contact our experts



North & South America

Michael Asmussen
Business Development Manager

T: +45 4412 0383
ma@blue-line.com



Europe & Asia

Ole Sanggaard Knudsen
Business Development Manager

T: +45 6646 8624
osk@blue-line.com



Denmark

Kim Lindberg
Key Account Manager

T: +45 2225 8746
kl@blue-line.com

Blue Line headquarters



Blue Line A/S

Kappa 8
8382 Hinnerup
Denmark

T: +45 8678 5000
sales@blue-line.com
www.blue-line.com

International offices:

Blue Line IT Inc.
200 Trans Air Dr.
Morrisville, NC 27560
USA

Blue Line Norway AS
Fjordveien 1
1363 Høvik
Norway

Blue Line Sweden AB
Torshamnsgatan 27
164 40 Kista
Sweden